

# RoboCupJunior Rescue Line - Rules

## 2022 Draft 01

RoboCupJunior Rescue Technical Committee 2021		
Chair	Kai Junge	UK
	Naomi Chikuma	Japan
	Tom Linnemann	Germany
	Ryo Unemoto	Japan
	Elizabeth Mabrey	USA
	Tatiana Pazelli	Brazil
	Alexis Cosette Arizaga	Mexico

RoboCupJunior General Chairs 2021			Trustees representing RoboCupJunior	
General Chair	Luis José Lopez Lora	Mexico	Amy Eguchi	USA
General Co-chair	Irene Kipnis	Israel	Fernando Ribeiro	Portugal
General Co-chair	Julia Maurer	USA	Gerard Elias	Australia
Chair support	Nerea de la Riva Iriepa	Sweden	Gerald Steinbauer	Austria
Chair support	Shoko Niwa	Japan		

## Official Resources

RoboCupJunior Official Website	RoboCupJunior Official Forum	RCJ Rescue Community Website
<p><a href="https://junior.robocup.org">https://junior.robocup.org</a></p>	<p><a href="https://junior.forum.robocup.org">https://junior.forum.robocup.org</a></p>	<p><a href="https://rescue.rcj.cloud">https://rescue.rcj.cloud</a></p>



Corrections and clarifications to the rules may be posted on the Forum in advance of updating this rule file. It is the responsibility of the teams to review the forum to have a complete vision of these rules.

# Before you read the rules

Please read through the [RoboCupJunior General Rules](#) before proceeding on with these rules, as they are the premise for all rules. The English rules published by the RoboCupJunior Rescue Technical Committee are the only first draft rules for RoboCupJunior Rescue Line 2022. The translated versions that can be published by each regional committee are only reference information for non-English speakers to better understand the rules. It is the responsibility of the teams to have read and understood the official rules.

## Scenario

The land is simply too dangerous for humans to reach the victims. Your team has been given a difficult task. The robot must be able to carry out a rescue mission in a fully autonomous mode with no human assistance. The robot must be durable and intelligent enough to navigate through treacherous terrain with hills, uneven land and rubble without getting stuck. Along the path, the robot may need to be on the lookout for a rescue first aid kit that will later be made available to live victims, if it is not already carrying it. When the robot finally finds the victims in the evacuation zone, it has to gently and carefully transport the victims to the safe evacuation point, together with the rescue kit, where humans can take over the rescue. The robot should exit the evacuation zone after a successful rescue, to continue on its mission throughout the disaster scene until it exits the site. Time and technical skills are the essential! Come prepared to be the most successful rescue team.

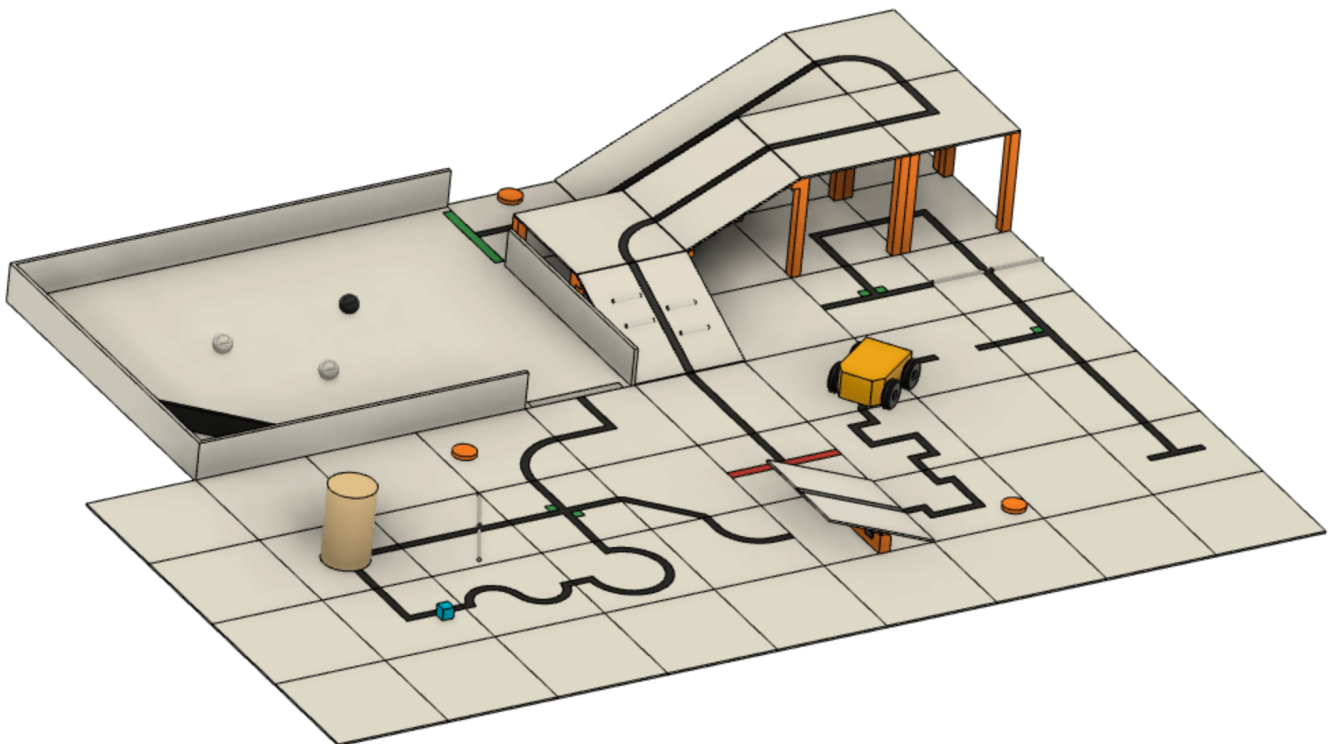

# Summary

An autonomous robot should follow a black line while overcoming different problems in a modular field formed by tiles with different patterns. The floor is white in colour and the tiles are on different levels connected with ramps.

Teams are not allowed to give their robot any information in advance about the field as the robot is supposed to recognize the field by itself. The robot earns points as follows:

- 10 points for following the correct path on a tile at an intersection or a dead end.
- 15 points for navigating through a seesaw tile.
- 15 points for overcoming an obstacle (bricks, blocks, weights, and other large, heavy items). A robot is expected to navigate the various obstacles.
- 10 points for reacquiring the line after a gap.
- 10 points for successfully navigating through a ramp (i.e. up and down successfully).
- 5 points for negotiating a speed bump.

If the robot gets stuck in the field, it can be restarted at the last visited checkpoint. The robot will earn points when it reaches new checkpoints. Somewhere on the path there will be a rectangular zone with walls (the evacuation zone). The entrance to this zone will be marked with a strip of reflective silver tape on the floor, and the exit of this zone will be marked with a strip of green tape on the floor.

Once inside the evacuation zone, the robot should locate and transport live victims (reflective silver balls of 4-5 cm diameter that are electrically conductive) and dead victims (black balls of 4-5 cm diameter that are not electrically conductive) to the evacuation point. A rescue kit is to be delivered to the live victims by transporting it to the evacuation point as well. The robot can earn multipliers for victim evacuations, depending on the difficulty level and the order of rescue, and rescue kit delivery. The robot may face obstacles/speed bumps/debris in the evacuation zone, but the robot will not score points by negotiating these difficulties here. The robot should then exit the evacuation zone and follow the line until the goal tile of the course is reached.

# Contents

1. Code of Conduct .....	6
1.1. Spirit.....	6
1.2. Fair Play .....	6
1.3. Behavior .....	6
1.4. Mentors .....	6
1.5. Ethics and Integrity.....	7
1.6. Sharing .....	7
2. Field .....	7
2.1. Description.....	7
2.2. Floor .....	8
2.3. Line .....	8
2.4. Checkpoints .....	9
2.5. Speed Bumps, Debris and Obstacles.....	9
2.6. Intersections and Dead Ends.....	9
2.7. Seesaws .....	10
2.8. Evacuation Zone .....	11
2.9. Victims .....	12
2.10. Rescue Kit.....	12
2.11. Environmental Conditions .....	13
3. Robots.....	13
3.1. Control.....	13
3.2. Construction .....	13
3.3. Team .....	14
3.4. Inspection .....	14
3.5. Violations.....	15
4. Play.....	15
4.1. Pre-game Practice.....	15
4.2. Humans .....	15
4.3. Start of Game.....	16
4.4. Scoring Run.....	16
4.5. Lack of Progress .....	17
4.6. Scoring.....	18
4.7. End of Game .....	20
5. Open Technical Evaluation .....	21
5.1. Description.....	21
5.2. Evaluation Aspects .....	21
5.3. Sharing .....	22



6. Conflict Resolution .....	22
6.1. Referee and Referee Assistant .....	22
6.2. Rule Clarification .....	22
6.3. Special Circumstances .....	22

# 1. Code of Conduct

## 1.1. Spirit

1. It is expected that all participants (students and mentors alike) respect the aims and ideals of RoboCupJunior as set out in our mission statement.
2. The volunteers, referees and officials will act within the spirit of the event to ensure the competition is competitive, fair and, most importantly, fun.
3. **It is not whether you win or lose, but how much you learn that counts!**

## 1.2. Fair Play

1. Robots that cause deliberate or repeated damage to the field will be disqualified.
2. Humans that cause deliberate interference with robots or damage to the field will be disqualified.
3. It is expected that the aim of all teams is to participate fairly.

## 1.3. Behavior

1. Each team is responsible for verifying the latest version of the rules on the RoboCupJunior Official website, and additional clarifications/corrections on the official forum made by the RoboCupJunior Rescue Committee prior to the competition.
2. Participants should be mindful of other people and their robots when moving around the tournament venue.
3. Participants are not allowed to enter setup areas of other leagues or other teams, unless explicitly invited to do so by team members.
4. Teams will be responsible for checking updated information (schedules, meetings, announcements, etc.) during the event. Updated information will be provided on notice boards in the venue, on the local competition website, and/or the RoboCup or RoboCupJunior websites if possible.
5. Participants and their companions who misbehave may be asked to leave the venue and risk being disqualified from the tournament.
6. These rules will be enforced equally to all participants at the discretion of the referees, officials, tournament organizers and local law enforcement authorities.
7. Teams are expected to be present at the venue early on the setup day as important activities will occur. These activities include, but are not limited to: registration, participation raffle, interviews, captains and mentor's meetings, among others.

## 1.4. Mentors

1. Non-team members (mentors, teachers, parents and other family, chaperones, translators and other adult team members) are not allowed in the student work area.

2. Mentors are not permitted to be involved in building, repairing, or programming their team's robots both before and during the competition.
3. Mentor interference with robots or referee decisions will result in a warning in the first instance. If this behavior recurs, the team could face a possible elimination from the tournament.
4. Robots have to be the work of the students. Any robot that appears to be identical to another robot may be prompted for re-inspection.

## 1.5. Ethics and Integrity

1. Fraud and misconduct are not condoned. Fraudulent acts may include the following:
  - a. Mentors working on the software or hardware of student's robot(s) during the competition.
  - b. More experienced/advanced groups of students may provide advice but should not do the work for other groups. Otherwise, the team risks being disqualified.
2. RoboCupJunior reserves the right to revoke an award if fraudulent behavior can be proven after the award ceremony takes place.
3. If it is evident that a mentor intentionally violates the code of conduct, and modifies and works on the student's robot(s) during the competition, the mentor will be banned from future participation in RoboCupJunior competitions.
4. Teams that violate the code of conduct can be disqualified from the tournament. It is also possible to disqualify a single team member from further participation in the tournament.
5. In less severe cases of violations of the code of conduct, a team will be given a warning. In severe or repeated cases of violations of the code of conduct, a team can be disqualified immediately without warning.

## 1.6. Sharing

1. The spirit of world RoboCup competitions is that any technological and curricular developments should be shared with other participants after the tournament. This furthers the mission of RoboCupJunior as an educational initiative.
2. Any developments may be published on the RoboCupJunior website after the event.
3. Participants are strongly encouraged to ask questions to their fellow competitors to foster a culture of curiosity and exploration in the fields of science and technology.

# 2. Field

## 2.1. Description

1. The field is made up of modular tiles, which can be used to make an endless number of different courses for the robots to traverse.
2. The field will consist of 30 cm x 30 cm tiles, with different patterns. The final selection of tiles and

their arrangement will not be revealed until the day of the competition. Competition tiles may be mounted on a hard-backing material of any thickness.

3. There will be a minimum of 8 tiles in a competition field, excluding the start and goal tile.
4. There are different tile designs (examples can be found under [Section 2.3, "Line"](#)).

## 2.2. Floor

1. The floor is white in colour. The floor may be either smooth or textured (like linoleum or carpet) and may have steps of up to 3 mm height in between tiles. Due to the nature of the tiles, there may be a step and/or gaps in the construction of the field.
2. Competitors should be aware that tiles may be mounted on thick backing or raised off the ground, which may make it difficult to get back on a tile where the robot comes off the course. No provision will be made to assist robots that drive off of a tile to get back onto the tile.
3. Tiles will be used as ramps to allow the robots to "climb" up to and down from different levels. Ramps will not exceed an incline of 25 degrees from the horizontal.
4. Robots must be designed so that they can navigate under tiles that form bridges over other tiles. Tiles placed above other tiles will be supported by pillars placed at tile corners with a square cross section of 25mm x 25mm, making each tile entrance/exit 25 cm. The minimum height (space between the floor and the ceiling) will be 25 cm.

## 2.3. Line

1. The black line, 1-2 cm wide, may be made with standard electrical insulating tape or printed onto paper or other materials. The black line forms a path on the floor. (The grid lines indicated in the drawings below are for reference only and competitors can expect tiles to be added and/or omitted.)
2. Straight sections of the black line may have gaps with at least 5 cm of straight line before each gap as measured from the shortest portion of the straight portion of the line. The length of a gap will be no more than 20 cm.
3. The arrangement of the tiles and paths may vary between rounds.
4. The line will be 10 cm away from any edge of the field, walls, pillars to support ramps, and obstacles that do not lie ahead of the path of the robot.
5. The line will end with a goal tile, which has a 25mm x 300mm strip of red tape in the centre of the tile, perpendicular to the incoming line.



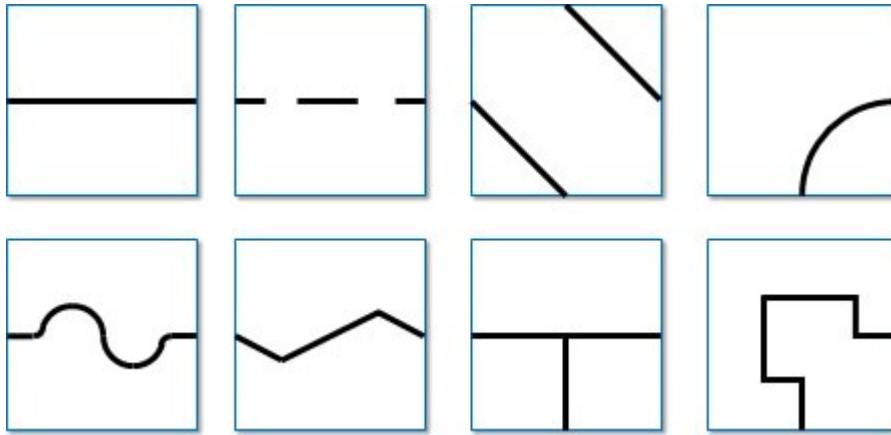

## 2.4. Checkpoints

1. A checkpoint is a tile which a robot will be manually placed back when a lack of progress occurs.
2. Checkpoints will not be located on tiles with scoring elements.
3. The start tile is a checkpoint where the robot can restart.
4. A checkpoint marker is the marker that indicates for humans which tiles are checkpoints. A disk with 5 mm to 12 mm thickness and up to 70 mm in diameter has been used frequently, but can be different dependent on the organizer.
5. The number of checkpoint markers and their locations will be predetermined by the field designers.

## 2.5. Speed Bumps, Debris and Obstacles

1. Speed bumps will have a height of 1 cm or less and will be white. When the speed bump is placed over any black line, the overlap between the speed bump and the black line will be coloured black.
2. Debris will have a maximum height of 3 mm. It will not be fixed to the floor. Debris consists of small materials such as toothpicks or small wooden dowels, etc.
3. Obstacles may consist of bricks, blocks, weights and other large, heavy items. Obstacles will be at least 15 cm high, and can be fixed to the floor.
4. An obstacle will not occupy more than one line and/or tile.
5. A robot is expected to navigate around obstacles. The robot may move obstacles but it should be noted that obstacles may be very heavy or fixed to the floor. Obstacles that are moved will remain where they were moved to, even if that prevents the robot from proceeding.
6. Obstacles will not be placed closer than 25 cm from the edge of the field (including edges of tiles that are elevated by ramps) and inclined tiles.

## 2.6. Intersections and Dead Ends

1. Intersections can be placed anywhere except in the evacuation zone.
2. Intersections markers are green and 25 mm x 25 mm in dimension. They indicate the direction of the path the robot should follow.

- If there is not a green marker at an intersection, the robot should continue straight ahead.
- A dead end is when there are two green marks before an intersection (one on each side of the line), in this case the robot should turn around.
- The intersections are always perpendicular but may have 3 or 4 branches.
- Intersection markers will be placed just before the intersection. See the images below for possible scenarios.

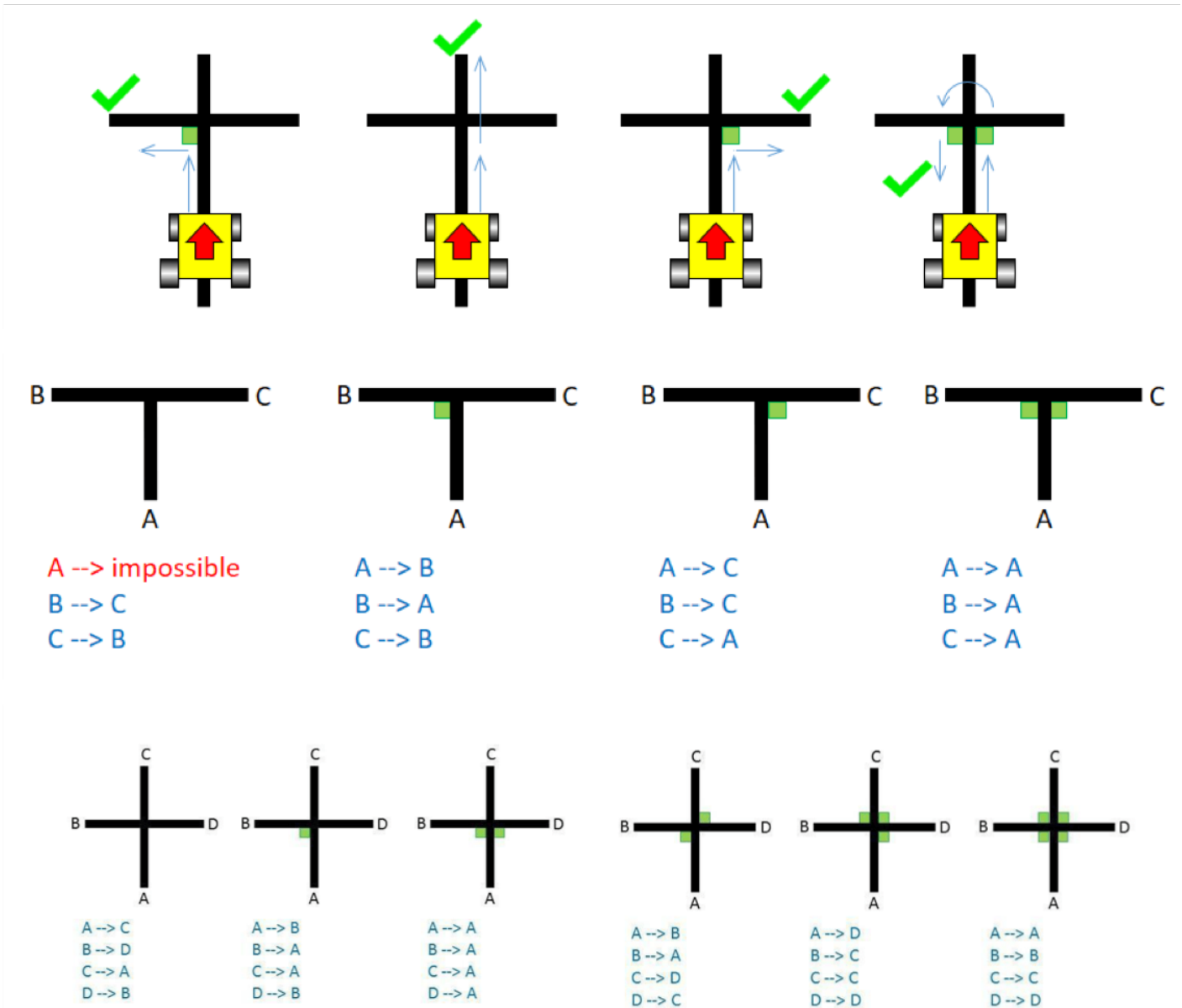

## 2.7. Seesaws

- A seesaw is comprised of a tile which can pivot around a hinge placed in the centre of a regular tile.
- The seesaw will have an incline of less than 20 degrees when tilted to one side.
- The seesaw tile will have a straight line with no scoring elements present.

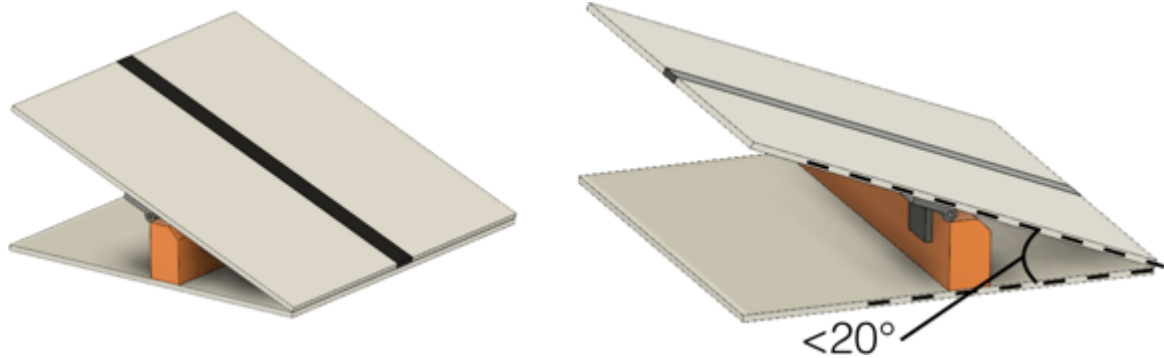

## 2.8. Evacuation Zone

1. The black line will end at the entrance of the evacuation zone.
2. The black line will begin again at the exit of the evacuation zone.
3. The evacuation zone is 120 cm by 90 cm with walls around the 4 sides that are at least 10 cm high and coloured white.
4. At the entrance to the evacuation zone, there is a 25 mm × 250 mm strip of reflective silver tape on the floor.
5. At the exit of the evacuation zone, there is a 25 mm × 250 mm strip of green tape on the floor.
6. Teams can choose between two different evacuation points, which are both right angled triangles with sides of 30 cm × 30 cm:
  - Level one: The evacuation point is a black triangle with a bump of 5mm along the side that does not touch a wall.
  - Level two: The evacuation point is a black triangle with 6 cm walls and a hollow centre.
7. The evacuation point can be placed in any of the non-entry/exit corners in the evacuation zone, randomly defined by the referee rolling a dice.
8. After a Lack of Progress, the referee may roll the dice again and place the evacuation point in a new corner.
9. The evacuation point will be fixed to the floor, but teams should be prepared for slight movements in the evacuation point.

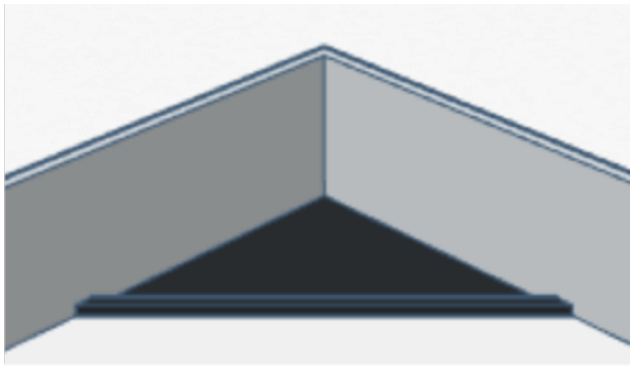

**Level 1**

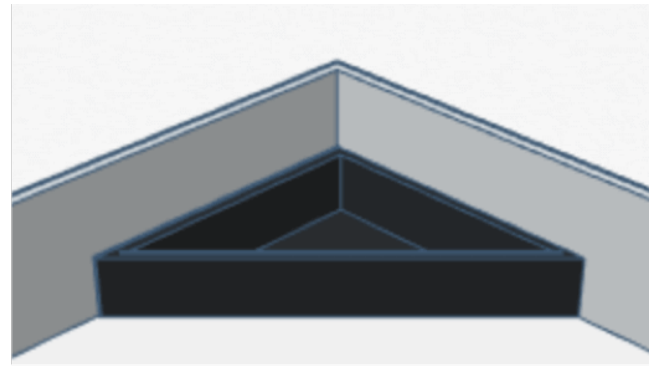

**Level 2**

## 2.9. Victims

1. Victims may be located anywhere on the floor of the evacuation zone.
2. A victim represents a person and is in the form of a 4-5 cm diameter ball with a maximum weight of 80 g.
3. There are two types of victims:
  - Dead victims are black and not electrically conductive.
  - Living victims are silver, reflect light and are electrically conductive.
4. The victims will be located randomly in the evacuation zone. There will be exactly two live victims and one dead victim placed in the evacuation zone.

## 2.10. Rescue Kit

1. A rescue kit is represented by a lightweight block with dimensions 3 cm × 3 cm × 3 cm of under 50 g, and it will be a blue colour.
2. Teams can either choose level one: to carry a rescue kit from the start tile and drop it off into the evacuation point, or level two: to have the rescue kit on the path towards the evacuation zone.
3. If the team chooses the rescue kit to be placed on the path (level two rescue kit), the placement will be on any tile prior to the evacuation zone, but with at least 15 cm from any gaps, speed bumps, inclined tiles, walls, obstacles, and edges of the field. The location of placement will be decided by the field designers.
4. For teams that choose a level one evacuation point and level two rescue kit, the rescue kit will be placed after the final speed bump and obstacle before the evacuation zone.
5. For teams that choose the rescue kit to be placed on the path (level two rescue kit), when viewed from above, the furthest point of the rescue kit will be maximum 5 cm from a nearby black line.

## 2.11. Environmental Conditions

1. The environmental conditions at a tournament may be different from the conditions at home. Teams must come prepared to adjust their robots to the conditions at the venue.
2. Lighting and magnetic conditions may vary in the rescue field.
3. The field may be affected by magnetic fields (e.g. generated by under floor wiring and metallic objects). Teams should prepare their robots to handle such interference.
4. The field may be affected by unexpected lighting interference (e.g. such as camera flash from spectators). Teams should prepare their robots to handle such interference.
5. All measurements in the rules have a tolerance of  $\pm 5\%$ .

## 3. Robots

### 3.1. Control

1. Robots must be controlled autonomously. The use of a remote control, manual control, or passing information (by external sensors, cables, wirelessly, etc.) to the robot is not allowed.
2. Robots must be started manually by the team captain.
3. Any pre-mapped type of dead reckoning (movements preprogrammed based on known locations or placement of features in the field) is prohibited.
4. Robots must not damage any part of the field in any way.

### 3.2. Construction

1. Any robot kit or building blocks, either available on the market or built from raw hardware, may be used as long as the design and construction of the robot are primarily and substantially the original work of the students.
2. Teams are not permitted to use any commercially produced robot kits or sensors components that are specifically designed or marketed to complete any single major task of RoboCupJunior Rescue. Robots that do not comply will face immediate disqualification from the tournament. If there is any doubt, teams should consult the RoboCupJunior Rescue Committee prior to the competition.
3. For the safety of participants and spectators, only lasers of class 1 and 2 are allowed. This will be checked during inspection. Teams using lasers must have the datasheet of the laser, and also must submit them prior to the competition as well as be able to show them during the competition.
4. Wireless communication must be used correctly as described on the [RoboCupJunior General Rules](#). Robots performing other types of wireless communication need to be deleted or disabled. If the robot has other forms of wireless communication equipment, the team needs to prove that they are disabled. Non-conforming robots may be immediately disqualified from the tournament.
5. Robots may incur damage by falling off the field, making contact with another robot, or making contact with field elements. The RoboCupJunior Rescue Committee cannot anticipate all potential

situations where damage to the robot may occur. Teams should ensure that all active elements on a robot are properly protected with resistant materials. For example, electrical circuits must be protected from all human contact and direct contact with other robots and field elements.

6. When batteries are transported, moved, or charged, it is strongly recommended that safety bags be used. Reasonable efforts should be made to ensure that robots avoid short circuits and chemical or air leaks.
7. Robots must be equipped with a handle which is to be used to pick them up during the scoring run.
8. Robots must be equipped with a single binary switch or button of any kind, clearly visible to the referee, for restarting the robot when a lack of progress occurs.

### 3.3. Team

1. Each team must have only one robot on the field.
2. Each team must comply with the [RoboCupJunior General Rules](#) regarding the number of members and each member's age.
3. Each team member will need to explain their work and should have a specific technical role.
4. A student can be registered on only one team across all RoboCupJunior leagues/sub-leagues.
5. A team is only allowed to participate in one league/sub-league in across all RoboCupJunior leagues/sub-leagues.
6. Team members may compete in Rescue Line twice (2 international events). After competing in Rescue Line twice, they must move to another RoboCupJunior sub-leagues. A student will not be able to participate in the RoboCupJunior Bangkok 2022 if he/she has participated in any two of the following international competitions: RoboCupJunior Hefei 2015 Rescue Line Secondary, RoboCupJunior Leipzig 2016 Rescue Line Secondary, RoboCupJunior Nagoya 2017 Rescue Line, RoboCupJunior Montreal 2018 Rescue Line or RoboCupJunior Sydney 2019 Rescue Line.
7. Mentors/parents are not allowed to be with the students during the competition. The students will have to govern themselves (without mentor's supervision or assistance) during the long stretch of hours at the competition.

### 3.4. Inspection

1. The robots will be scrutinized by a panel of referees before the start of the tournament and at other times during the competition to ensure that they meet the constraints described in these rules.
2. It is illegal to use a robot that is very similar to another team's robot from a previous year or the current year.
3. It is the responsibility of the team to have their robot re-inspected, if their robot is modified at any time during the tournament.
4. Students will be asked to explain the operation of their robot in order to verify that construction and programming of the robot is their own work.
5. Students will be asked about their preparation efforts and may be requested to answer surveys and participate in video-taped interviews for research purposes.

6. All teams must complete a web form prior to the competition to allow referees to better prepare for the interviews. Instructions on how to submit the form will be provided to the teams prior to the competition.
7. All teams have to submit their source code prior to the competition. The source code will not be shared with other teams without the team's permission.
8. All teams must submit their engineering journal prior to the competition. The journals will not be shared with other teams without the team's permission.



However, it is highly recommended that teams publicly share their engineering journal. With the teams that indicate that their engineering journals could be shared publicly during the registration process, the journal alongside their poster presentation will be shared through the RoboCupJunior Forum so that other teams could learn from them.

## 3.5. Violations

1. Any violations of the inspection rules will prevent the offending robot from competing until modifications are made and the robot passes inspection.
2. Modifications must be made within the time schedule of the tournament and teams cannot delay tournament play while making modifications.
3. If a robot fails to meet all specifications (even with modifications), it will be disqualified from that game (but not from the tournament).
4. No mentor assistance is allowed during the competition. (see [Section 1, "Code of Conduct"](#).)
5. Any violations of the rules may be penalized by disqualification from the tournament or the game or may result in a loss of points at the discretion of the referees, officials, RoboCupJunior Rescue Committee or RoboCupJunior General Chairs.

## 4. Play

### 4.1. Pre-game Practice

1. When possible, teams will have access to practice fields for calibration and testing throughout the competition.
2. Whenever there are dedicated independent fields for competition and practice, it is at the organizers' discretion if testing is allowed on the competition fields.

### 4.2. Humans

1. Teams should designate one of their members as "captain" and another one as "co-captain". Only these two team members will be allowed access to the competition fields, unless otherwise directed by a referee. Only the captain will be allowed to interact with the robot during a scoring run.
2. The captain can move the robot only when they are told to do so by a referee.

3. Other team members (and any spectators) within the vicinity of the competition field have to stand at least 150 cm away from the field at all times, unless otherwise directed by a referee.
4. No one is allowed to touch the fields intentionally during a scoring run.
5. Any and all pre-mapping activities will result in immediate disqualification of the robot for the round. Pre-mapping is the act of humans providing the robot with information about the field (e.g.: location of obstacles, entrance to the evacuation zone, number of tiles after the evacuation zone, etc...) prior to the game.

### 4.3. Start of Game

1. Teams must choose level one or two separately for the evacuation point and the rescue kit prior to the start of the game.
2. Each team has a maximum of 8 minutes for a game. The game includes the time for calibration and the scoring run.
3. Calibration is defined as taking sensor readings and modifying the robot's programming to accommodate such sensor readings. Calibration does not count as pre-mapping.
4. The scoring run is defined as the time when the robot is moving autonomously to navigate the field, and the referee will record the scores.
5. A game begins at the scheduled starting time whether or not the team is present or ready. Start times will be posted around the venue.
6. Once the game has begun, the robot is not permitted to leave the competition area.
7. Teams may calibrate their robot in as many locations as desired on the field, but the clock will continue to run. Robots are not permitted to move on their own while calibrating.
8. Once a team is ready to start a scoring run, they must notify the referee. To begin a scoring run, the robot is placed on the start tile of the course as indicated by the referee. Once a scoring run has begun, no more calibration is permitted, including changing of code/code selection.
9. Teams may choose not to calibrate the robot and instead immediately start the scoring run.
10. Once a robot begins its scoring run, the referee will roll a standard 6-sided dice to determine in which corner the evacuation point will be located.
11. Individual tiles, obstacles, and other scoring elements may be removed, added, or changed when the robot starts moving (as the scoring run begins), to prevent teams from pre-mapping the layout of the fields. This may happen on the basis of a die rolled by the referee or with another method of randomization announced by the organizers. For a particular field during a round, the referee will ensure the difficulty of the field will be kept similar and the maximum points to be constant.

### 4.4. Scoring Run

1. Robots will start behind the joint of the start tile and the subsequent tile along the course. Correct placement will be checked by the referee.
2. Modifying the robot during a scoring run is prohibited, which includes remounting parts that have fallen off.



3. Any parts that the robot loses intentionally or unintentionally will be left in the field until the run is over. Team members and referees are not allowed to move or remove parts from the field during a scoring run.
4. Teams are not allowed to give their robot any advance information about the field. A robot is supposed to recognize the field elements by itself.
5. The robot must follow the course completely to enter the evacuation zone, and then out of the evacuation zone towards the goal tile.
6. The robot has visited a tile when more than half the robot is within that tile when viewed from above.

## 4.5. Lack of Progress

1. A lack of progress occurs when:
  - a. a team captain declares a lack of progress.
  - b. a robot loses the black line without regaining it by the next tile in the sequence (see figures at end of the section).
  - c. a robot reaches a line that is not in the intended sequence.
2. If a lack of progress occurs, the robot must be positioned on the previous checkpoint tile facing the path towards the goal tile and checked by the referee.
3. After a lack of progress, the team must reset the robot by using a switch located in a clearly visible location by the referee (see [3.2.8](#)).
4. There is no limit to the number of lack of progresses within a round.
5. After three failed attempts to reach a checkpoint, a robot is allowed to proceed to the next checkpoint.
6. The team captain may choose to make further attempts at the course to earn the additional points available from scoring elements that have not already been earned before reaching the next checkpoint.
7. If a lack of progress occurs in the evacuation zone, all victims (including ones that have rolled) will remain in their current position. Victims that are held by the robot will be placed roughly on the location of the robot when the lack of progress occurred in the evacuation zone. If a lack of progress occurs as the robot exits the evacuation zone whilst carrying victims, the victims will be randomly placed in the evacuation zone.
8. The rescue kit will be left in the exact location (even if it is located on the robot) when a lack of progress is called.
9. Any seesaws ahead of the robot's path can be moved to the favourable direction when a lack of progress is called.

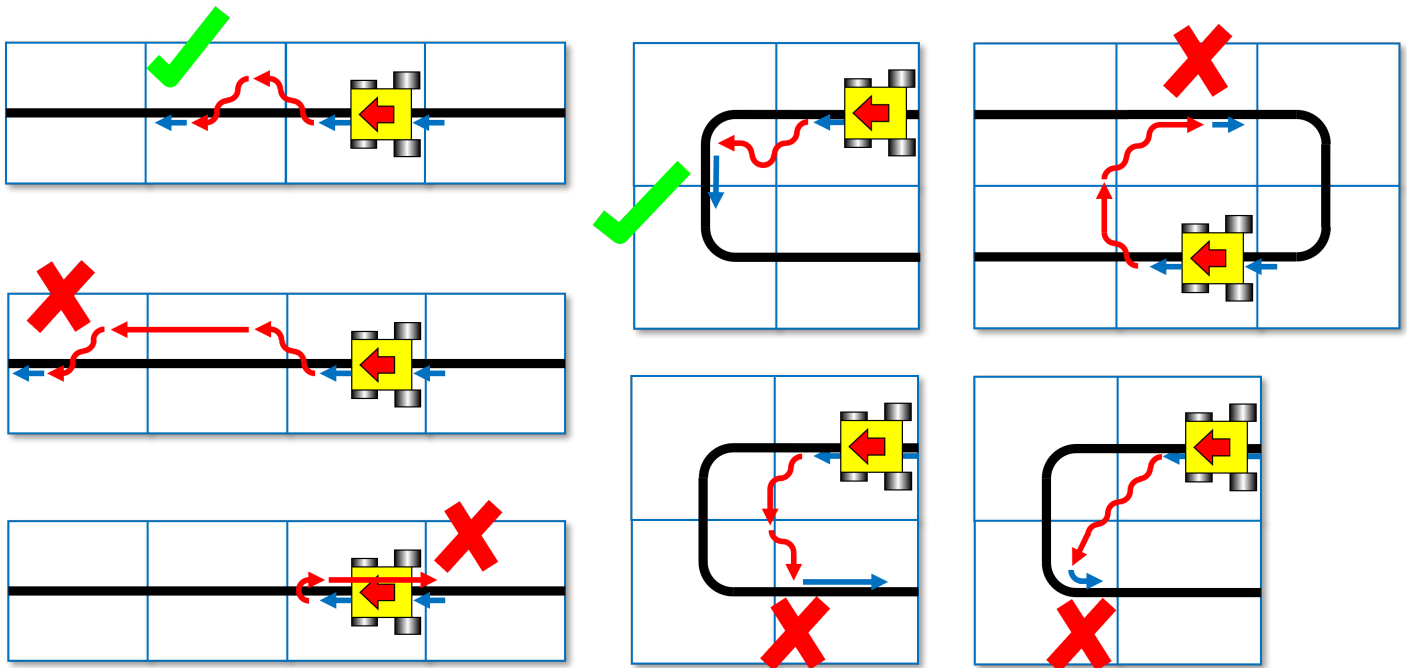

## 4.6. Scoring

1. A robot is awarded points for successfully navigating each hazard (gaps in the line, speed bumps, intersections, dead ends, ramps, obstacles, and seesaws). Points are awarded per hazard when the robot has reached the subsequent tile in sequence. A ramp as a hazard accounts for all of the inclined tiles that make up one ramp. Point allocations are, 10 points per gap, 5 points per speed bump, 10 points per intersection/dead end, 10 points per ramp, 15 points per obstacle, and 15 points per seesaw.
2. Failed attempts at navigating hazards in the field are defined as a Lack of Progress (see [Section 4.5, "Lack of Progress"](#)).
3. When a robot reaches a checkpoint tile it will earn points for each tile it has passed since the previous checkpoint. The points per tile depend on how many attempts the robot has made to reach the checkpoint:
  - 1st attempt = 5 points/tile
  - 2nd attempt = 3 points/tile
  - 3rd attempt = 1 point/tile
  - Beyond the 3rd attempt = 0 points/tile

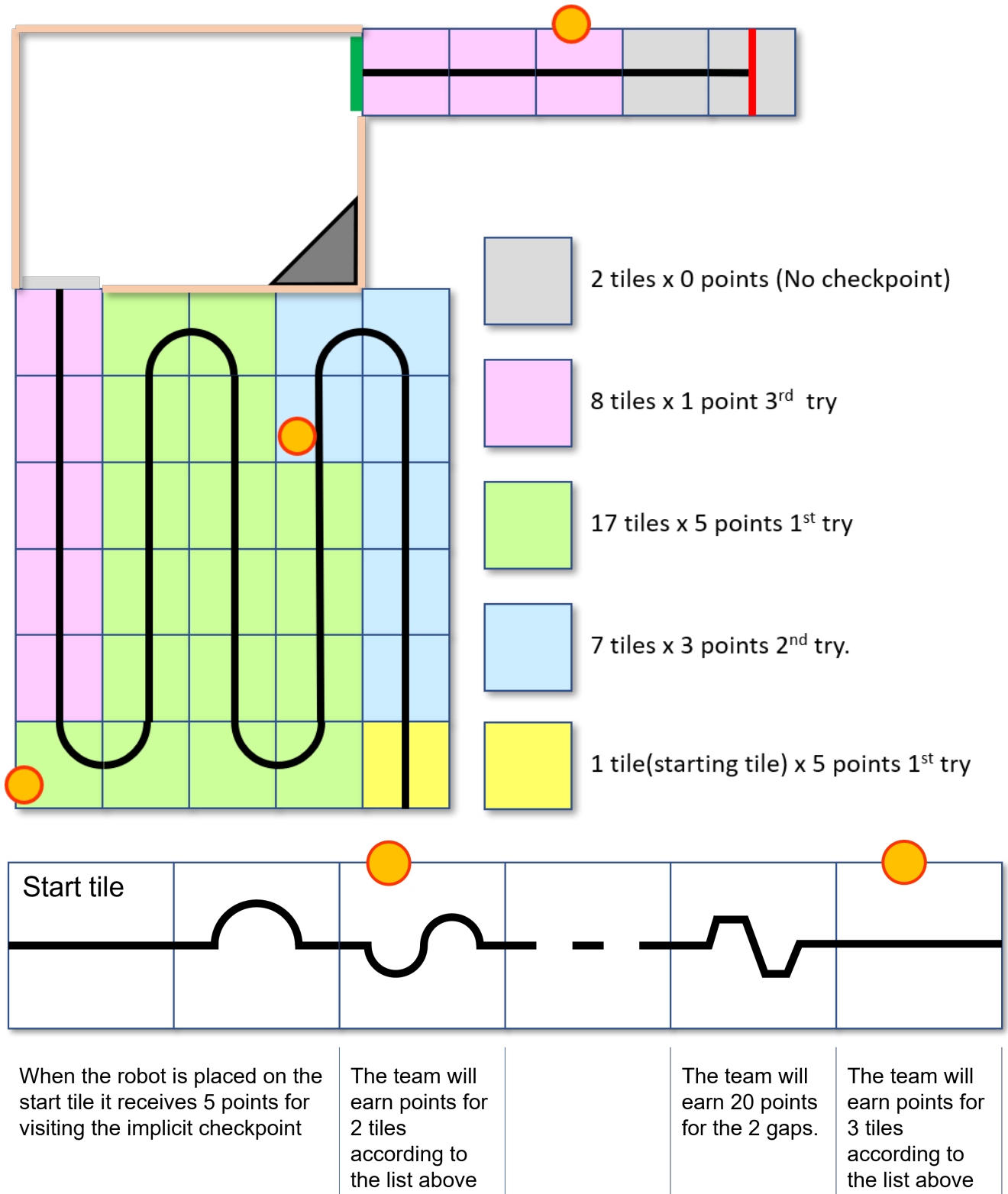

- Each gap, speed bump, intersection, dead end, ramp, obstacles, and seesaw can only be scored once per intended direction through the course. Points are not awarded for subsequent attempts through the course.
- Successful victim rescue: Robots are awarded multipliers for successfully rescuing victims. A successful victim rescue occurs when the victim is moved completely into the evacuation point, and no part of the robot can be in contact with the victim. When the referee determines there has been a successful victim rescue, the victim will be removed from the evacuation point to allow more victims to be evacuated. The multipliers are allocated as such:

- a. Level one evacuation point:
  - ×1.2 per successful rescue of a living victim
  - ×1.2 per successful rescue of the dead victim, if both the living victims have been successfully evacuated
- b. Level two evacuation point:
  - ×1.4 per successful rescue of a living victim
  - ×1.4 per successful rescue of the dead victim, if both the living victims have been successfully evacuated
6. Any hazards that are in the evacuation zone will not be counted towards additional points.
7. An additional multiplier will be awarded for the rescue kit placed completely inside an evacuation point, as such:
  - Level one evacuation point & Level one rescue kit: ×1.1
  - Level one evacuation point & Level two rescue kit: ×1.3
  - Level two evacuation point & Level one rescue kit: ×1.2
  - Level two evacuation point & Level two rescue kit: ×1.6
8. When a lack of progress occurs between checkpoints (or checkpoint and exit) containing an evacuation zone, 0.025 for level one evacuation point, 0.05 for level two evacuation point will be deducted from each of the obtained multiplier (however multipliers will not be less than 1).
9. An exit bonus is awarded when the robot has reached the goal tile and has completely stopped for more than 5 seconds (this time is included in the total 8 minutes). The exit bonus is a non-negative number and is given by  $60 - 5 \times (\text{number of lack of progress})$  points.
10. The multipliers obtained from evacuations are used to be multiplied to the total score obtained from the line tracing course as such:

$$(\text{TOTAL SCORE}) = (\text{LINE TRACING SCORE} + \text{EXIT BONUS}) \times (\text{EVACUATION ZONE MULTIPLIER})$$

11. The scores will be rounded to the nearest integer in each game.
12. Ties in scoring will be resolved based on the game time.

## 4.7. End of Game

1. A team may elect to stop the game early at any time. In this case, the team captain must indicate to the referee the team's desire to terminate the game. The team will be awarded all points earned up to the call for the end of the game. The referee will stop the time at the end of game which will be recorded as the game time.
2. The game ends when:
  - a. the 8 minutes of allowed game time expires
  - b. the team captain calls the end of the game

- c. the robot reaches the goal tile and completely stops for 5 seconds

## 5. Open Technical Evaluation

### 5.1. Description

1. Your technical innovation will be evaluated during a dedicated time frame. All teams need to prepare for an open display during this time frame.
2. Judges will circulate and interact with the teams. The Open Technical Evaluation is intended to be a casual conversation with a "question and answer" atmosphere.
3. The main objective of the Open Technical Evaluation is to emphasize the ingenuity of innovation. Being innovative may mean technical advances as compared to the existing knowledge, or an out-of-the-ordinary, simple but clever, solution to existing tasks.

### 5.2. Evaluation Aspects

1. A standardized rubric system will be used focusing on:
  - creativity
  - cleverness
  - simplicity
  - functionality
2. Your "work" can include (but is not limited to) one of the following aspects:
  - creation of your own sensor instead of a pre-built sensor
  - creation of a "sensor module" which is comprised of various electronics resulting in a self-contained module to provide a certain functionality
  - creation of a mechanical invention which is functional, but out of the ordinary
  - creation of a new software algorithm to a solution
3. Teams must provide documents that explain their work. Each invention must be supported by concise but clear documentation. The documents must show precise steps towards the creation of the invention.
4. Documents must include one poster and one engineering journal. Teams should be prepared to explain their work.
5. Engineering Journals should demonstrate your best practices in the development process.
6. The poster should include name of team, country, league, robot description, robot capabilities, controller and programming language used, sensors included, method of construction, time used for development, cost of materials and awards won by the team in its country, etc.

## 5.3. Sharing

1. Teams are encouraged to review other's posters and presentations.
2. Teams awarded with certificates are required to post their documents and presentation online when asked by the RoboCupJunior Rescue Committee.

# 6. Conflict Resolution

## 6.1. Referee and Referee Assistant

1. All decisions during game play are made by the referee or the referee assistant, who are in charge of the field, persons and objects surrounding them.
2. During game play, the decisions made by the referee and/or the referee assistant are final.
3. At conclusion of game play, the referee will ask the captain to sign the score sheet. Captains will be given a maximum of 1 minute to review the score sheet and sign it. By signing the score sheet, the captain accepts the final score on behalf of the entire team. In case of further clarification, the team captain should write their comments on the score sheet and sign it.

## 6.2. Rule Clarification

1. If any rule clarification is needed, please contact the [International RoboCupJunior Rescue Committee](#) through the [RoboCupJunior Forum](#).
2. If necessary even during a tournament, a rule clarification may be made by members of the [International RoboCupJunior Rescue Committee](#).

## 6.3. Special Circumstances

1. If special circumstances, such as unforeseen problems or capabilities of a robot occur, rules may be modified by the RoboCupJunior Rescue Committee Chair in conjunction with available committee members, even during a tournament.
2. If any of the team captains/mentors do not show up to the team meetings to discuss problems and the resulting rule modifications described at [6.3.1](#), it will be understood that they agreed and were aware of the changes.