



RoboCupJunior Rescue Maze - Rules

2022 Draft 01

RoboCupJunior Rescue Technical Committee 2021		
Chair	Kai Junge	UK
	Naomi Chikuma	Japan
	Tom Linnemann	Germany
	Ryo Unemoto	Japan
	Elizabeth Mabrey	USA
	Tatiana Pazelli	Brazil
	Alexis Cosette Arizaga	Mexico

RoboCupJunior General Chairs 2021			Trustees representing RoboCupJunior	
General Chair	Luis José Lopez Lora	Mexico	Amy Eguchi	USA
General Co-chair	Irene Kipnis	Israel	Fernando Ribeiro	Portugal
General Co-chair	Julia Maurer	USA	Gerard Elias	Australia
Chair support	Nerea de la Riva Iriepa	Sweden	Gerald Steinbauer	Austria
Chair support	Shoko Niwa	Japan		

Official Resources

RoboCupJunior Official Website	RoboCupJunior Official Forum	RCJ Rescue Community Website
 <p>https://junior.robocup.org</p>	 <p>https://junior.forum.robocup.org</p>	 <p>https://rescue.rcj.cloud</p>



Corrections and clarifications to the rules may be posted on the Forum in advance of updating this rule file. It is the responsibility of the teams to review the forum to have a complete vision of these rules.

Before you read the rules



Please read through the [RoboCupJunior General Rules](#) before proceeding on with these rules, as they are the premise for all rules. The English rules published by the RoboCupJunior Rescue Technical Committee are the only first draft rules for RoboCupJunior Rescue Maze 2022. The translated versions that can be published by each regional committee are only reference information for non-English speakers to better understand the rules. It is the responsibility of the teams to have read and understood the official rules.

Scenario

The land is simply too dangerous for humans to reach the victims. Your team has been given a difficult task. The robot must be able to carry out a rescue mission in a fully autonomous mode with no human assistance. The robot must be durable and intelligent enough to navigate through treacherous terrain with hills, uneven land and rubble without getting stuck. The robot must search for victims, dispense rescue kits, and signal the position of the victims so the humans can take over. Time and technical skills are essential! Come prepared to be the most successful rescue team.

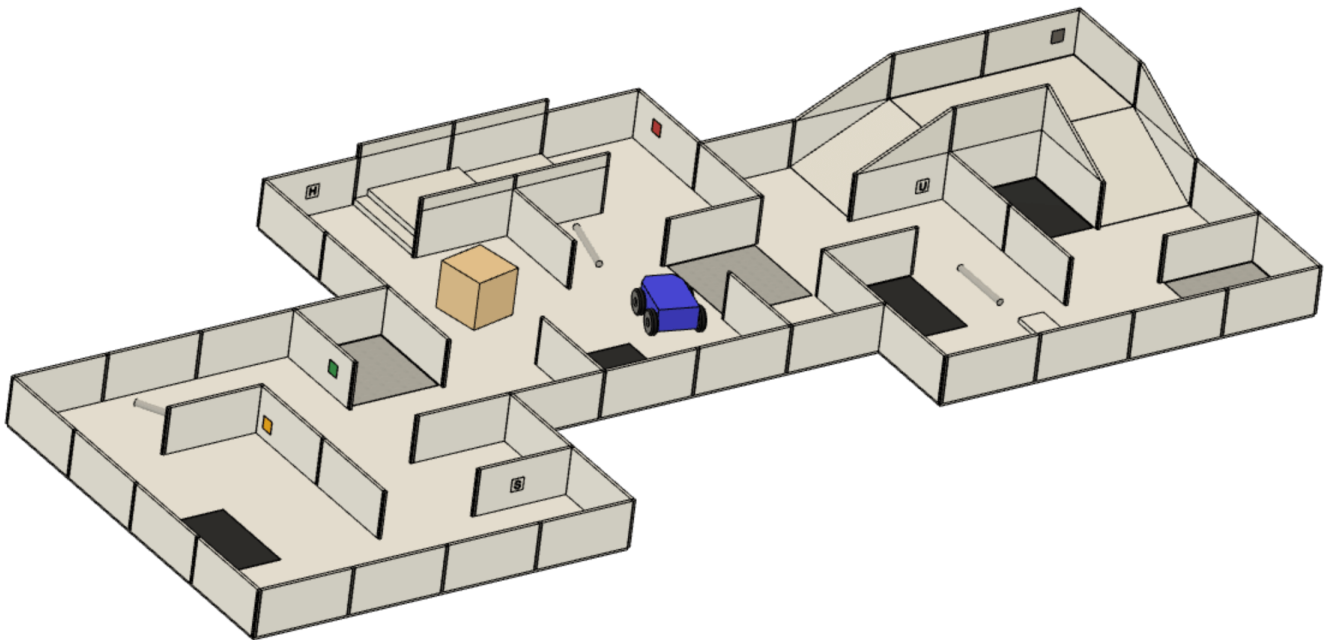

Summary

The robot needs to search through a maze for victims. The robot is not supposed to find the fastest path through the maze, instead it should explore as much of the maze as possible. The robot will be awarded 5, 10, 15, or 30 points for each coloured, heated, or visual victim detected, dependant on its location in the field. If the robot can successfully deliver a rescue kit close to a victim, it will earn an additional 10 points per rescue kit. The number of maximum additional points is dependent on the type of victim as follows.

- 10 points for a heated victim
- 30 points for a harmed visual victim
- 20 points for a stable visual victim
- No additional points for an unharmed visual victim
- 10 points for a red coloured victim
- 10 points for a yellow coloured victim
- No additional points for a green coloured victim

If the robot is stuck in the maze, it can be restarted at the last visited checkpoint. A reflective floor indicates checkpoints so the robot can save the position to a map (if it uses a map) in a non-volatile medium and restore it in case of a restart. The robot must also avoid areas with a black floor.

If the robot can find its way back to the beginning of the maze after exploring the whole maze it will receive an exit bonus. The robot will also earn a reliability bonus if the robot can exit the maze with a minimum number of restarts. If the robot can find its way back to the beginning after exploring the maze it will receive 10 bonus points per identified victim as an exit bonus.

The robot can earn additional points by navigating the following obstacles:

- 10 points for going up or down a ramp
- 10 points for each visited checkpoint
- 5 points for passing through each tile with speed bumps
- 5 points for navigating a set of stairs

Contents

1. Code of Conduct	5
1.1. Spirit.....	5
1.2. Fair Play	5
1.3. Behavior	5
1.4. Mentors	5
1.5. Ethics and Integrity.....	6
1.6. Sharing	6
2. Field	6
2.1. Description.....	6
2.2. Floor	7
2.3. Path	7
2.4. Speed Bumps, Debris, Obstacles, and Stairs	8
2.5. Victims	9
2.6. Rescue Kits	10
2.7. Environmental Conditions	10
3. Robots	11
3.1. Control.....	11
3.2. Construction	11
3.3. Team	12
3.4. Inspection	12
3.5. Violations.....	13
4. Play	13
4.1. Pre-game Practice.....	13
4.2. Humans	13
4.3. Start of Game.....	14
4.4. Scoring Run.....	14
4.5. Lack of Progress	15
4.6. Scoring.....	15
4.7. End of Game	17
5. Open Technical Evaluation.....	17
5.1. Description.....	17
5.2. Evaluation Aspects	17
5.3. Sharing	18
6. Conflict Resolution	18
6.1. Referee and Referee Assistant	18
6.2. Rule Clarification	18
6.3. Special Circumstances	19

1. Code of Conduct

1.1. Spirit

1. It is expected that all participants (students and mentors alike) respect the aims and ideals of RoboCupJunior as set out in our mission statement.
2. The volunteers, referees and officials will act within the spirit of the event to ensure the competition is competitive, fair and, most importantly, fun.
3. **It is not whether you win or lose, but how much you learn that counts!**

1.2. Fair Play

1. Robots that cause deliberate or repeated damage to the field will be disqualified.
2. Humans that cause deliberate interference with robots or damage to the field will be disqualified.
3. It is expected that the aim of all teams is to participate fairly.

1.3. Behavior

1. Each team is responsible for verifying the latest version of the rules on the RoboCupJunior Official website, and additional clarifications/corrections on the official forum made by the RoboCupJunior Rescue Committee prior to the competition.
2. Participants should be mindful of other people and their robots when moving around the tournament venue.
3. Participants are not allowed to enter setup areas of other leagues or other teams, unless explicitly invited to do so by team members.
4. Teams will be responsible for checking updated information (schedules, meetings, announcements, etc.) during the event. Updated information will be provided on notice boards in the venue, on the local competition website, and/or the RoboCup or RoboCupJunior websites if possible.
5. Participants and their companions who misbehave may be asked to leave the venue and risk being disqualified from the tournament.
6. These rules will be enforced equally to all participants at the discretion of the referees, officials, tournament organizers and local law enforcement authorities.
7. Teams are expected to be present at the venue early on the setup day as important activities will occur. These activities include, but are not limited to: registration, participation raffle, interviews, captains and mentor's meetings, among others.

1.4. Mentors

1. Non-team members (mentors, teachers, parents and other family, chaperones, translators and other adult team members) are not allowed in the student work area.

2. Mentors are not permitted to be involved in building, repairing, or programming their team's robots both before and during the competition.
3. Mentor interference with robots or referee decisions will result in a warning in the first instance. If this behavior recurs, the team could face a possible elimination from the tournament.
4. Robots have to be the work of the students. Any robot that appears to be identical to another robot may be prompted for re-inspection.

1.5. Ethics and Integrity

1. Fraud and misconduct are not condoned. Fraudulent acts may include the following:
 - a. Mentors working on the software or hardware of student's robot(s) during the competition.
 - b. More experienced/advanced groups of students may provide advice but should not do the work for other groups. Otherwise, the team risks being disqualified.
2. RoboCupJunior reserves the right to revoke an award if fraudulent behavior can be proven after the award ceremony takes place.
3. If it is evident that a mentor intentionally violates the code of conduct, and modifies and works on the student's robot(s) during the competition, the mentor will be banned from future participation in RoboCupJunior competitions.
4. Teams that violate the code of conduct can be disqualified from the tournament. It is also possible to disqualify a single team member from further participation in the tournament.
5. In less severe cases of violations of the code of conduct, a team will be given a warning. In severe or repeated cases of violations of the code of conduct, a team can be disqualified immediately without warning.

1.6. Sharing

1. The spirit of world RoboCup competitions is that any technological and curricular developments should be shared with other participants after the tournament. This furthers the mission of RoboCupJunior as an educational initiative.
2. Any developments may be published on the RoboCupJunior website after the event.
3. Participants are strongly encouraged to ask questions to their fellow competitors to foster a culture of curiosity and exploration in the fields of science and technology.

2. Field

2.1. Description

1. The field layout will consist of a collection of tiles with a horizontal floor, a perimeter wall, ramps, and walls within the field.
2. All tiles are defined as a 30 cm x 30 cm space.

3. All walls used to create the maze are at least 15 cm high from any floor or the peaks of stairs, 30 cm in length, and are mounted on the edges of the tiles.
4. Tiles will be used as ramps. They will have an incline with a maximum of 25 degrees from the horizontal and are always straight.

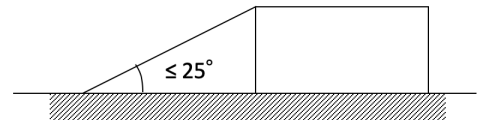
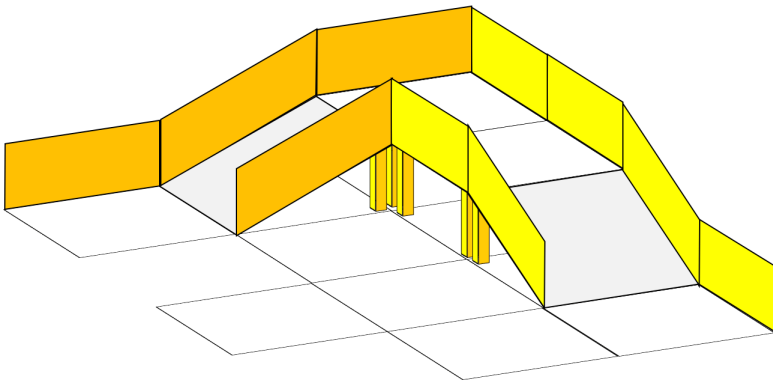

2.2. Floor

1. Floors may be either smooth or textured (like linoleum or carpet) and may have deviations of up to 3 mm in height between the tiles. There may be holes in the floor (approximately 5 mm in diameter), for fastening walls.
2. Black tiles:
 - a. Black tiles in the field represent holes, which the robot must avoid.
 - b. Black tiles will be ad randomly at the start of each game.
 - c. Black tiles may or may not be completely fixed to the floor.
3. Silver tiles:
 - a. Silver tiles in the field represent checkpoints.
 - b. Silver tiles will be placed randomly at the start of each game.
 - c. Silver tiles may or may not be completely fixed to the floor.

2.3. Path

1. Walls may or may not lead to the starting tile by following the left/right most wall consistently. Walls that lead to the starting tile are called "linear walls". The walls that do NOT lead to the starting tile are called "floating walls".
2. Black tiles will affect the determination of wall type (linear or floating), since they can be considered as virtual walls.

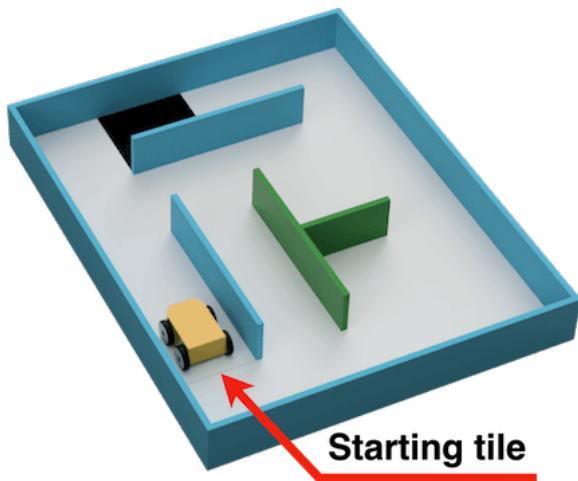

 **Linear walls**

 **Floating walls**

※The colour and walls configuration are for illustration only.

3. Teams must prepare for the pathways to be slightly smaller in dimension ($\pm 10\%$ variation on the tile size) than a tile due to the nature of placing walls.
4. Pathways for the robot are intended to be of the width of the tile and may open into foyers wider than the pathways.
5. One of the outermost tiles is the starting tile, where a robot should start and exit the run.
6. Walls may be removed, added or changed just before a scoring run starts to prevent teams pre-mapping the layout of the fields. Organizers will do their best to not change the length or difficulty of the maze when introducing these changes.

2.4. Speed Bumps, Debris, Obstacles, and Stairs

1. Speed bumps are fixed to the floor and have a maximum height of 2 cm.
2. Debris is not fixed to the floor and has a maximum height of 1 cm.
3. Obstacles:
 - a. have minimum height of 15 cm.
 - b. may consist of any large, heavy items.
 - c. may be fixed to the floor.
 - d. may be any shape including rectangular, pyramidal, spherical or cylindrical.
4. An obstacle may be placed in any location where at least 20 cm is left between the obstacle and any wall.
5. Obstacles that are moved or knocked over must remain where they are moved or fall and will not be reset during the scoring run.
6. Stairs of path x 30 cm space and maximum height is 2 cm.
7. The incline of stairs (i.e.: the incline of a plate to the horizontal when placed on the stairs) will be less than 25 degrees.
8. Stairs will be placed between walls.

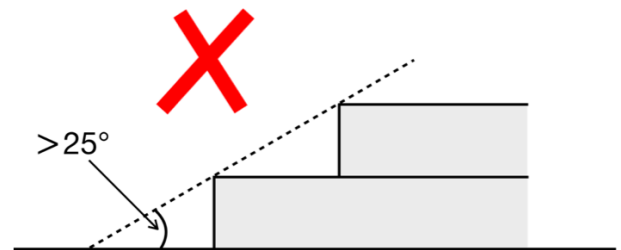
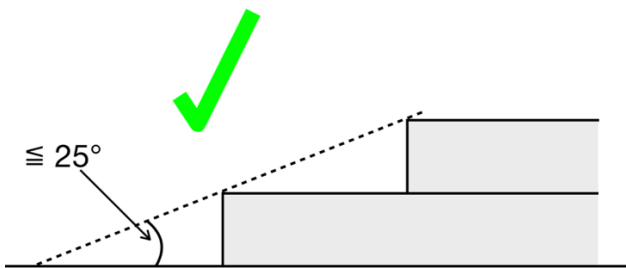
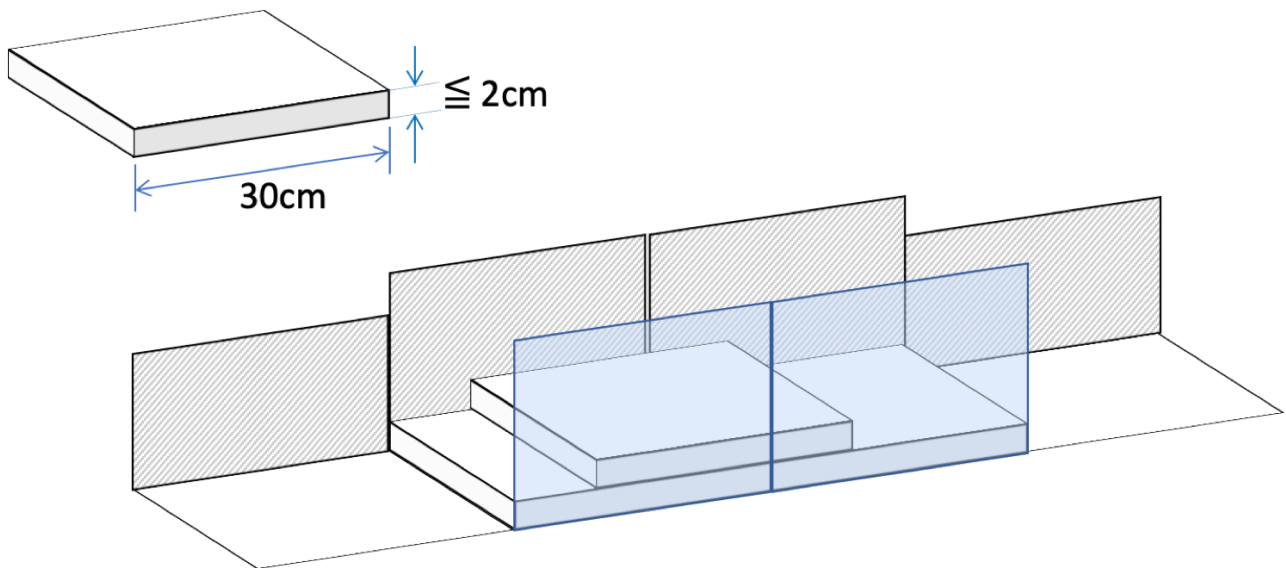

2.5. Victims

1. There are three types of victims: heated victims, visual victims, and coloured victims.
2. Victims are located near the floor of the field (located about 7 cm above the floor, see the figure below).

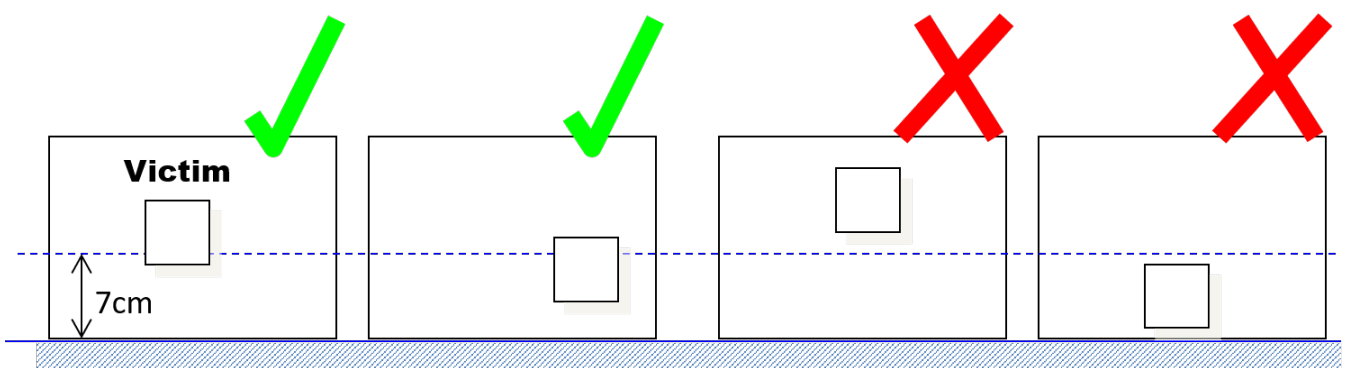

3. Victims will never be located on walls facing black/silver tiles, tiles with obstacles/speedbumps/stairs, and ramps.
4. There may be objects that resemble victims in appearance but are not victims. Such objects should not be identified as victims by robots.
5. Each heated victim has a surface area greater than 16 cm².
6. The temperature of the victim simulates human body temperature between 28°C to 40°C.

7. The organizers will try to keep a minimum difference of 10°C between heated victims' temperatures and the ambient temperature of the field.
8. Visual victims are uppercase letters printed on or attached to the wall. They are printed in black, using a sans serif typeface such as "Arial". Their height will be 4 cm. The letters represent the health status of the victim.
 - a. Harmed victim: H
 - b. Stable victim: S
 - c. Unharmed victim: U

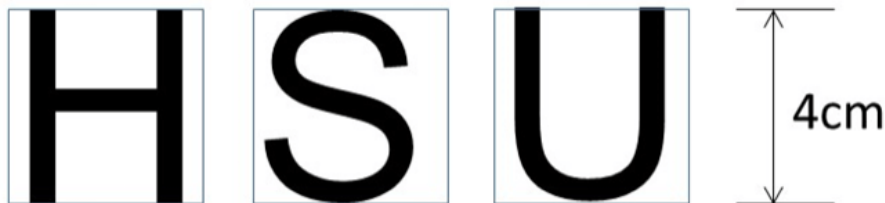

9. Coloured victims are printed on or attached to a wall. Their size will be 16 cm². Three colours are used: red, yellow, and green.

2.6. Rescue Kits

1. A rescue kit represents a basic health package distributed to a victim caught in a natural disaster. It symbolizes tools, medical supplies or devices used in the rescue process, such as GPS transponders or even something as simple as a light source.
2. Because we need to ensure that a rescue kit reaches the victim, it has to stay near the victim after the deployment. For example, it cannot roll away from or bounce away from the victim.
3. Each rescue kit must have a minimum volume of 1 cm³.
4. A robot can only carry a maximum number of 12 rescue kits.
5. Each team is responsible for their own rescue kit system, including bringing the rescue kits to the competition. The team captain is responsible for loading the rescue kits onto their robot and collecting it from the field with the referee's authorization after the end of the run.
6. Deployment of the rescue kit must be very clear to the referee.

2.7. Environmental Conditions

1. The environmental conditions at a tournament may be different from the conditions at home practice fields. Teams must come prepared to adjust their robots to the conditions at the venue.
2. Lighting and magnetic conditions may vary in the rescue field.
3. The field may be affected by magnetic fields (e.g. generated by under floor wiring and metallic objects). Teams should prepare their robots to handle such interference.
4. The field may be affected by unexpected lighting interference (e.g. such as camera flash from

spectators). Teams should prepare their robots to handle such interference.

5. The RoboCupJunior Rescue Committee will try their best to fasten the walls onto the field floor so that the impact from contact should not affect the robot.
6. All measurements in the rules have a tolerance of $\pm 10\%$.
7. Objects to be detected by the robot will be distinguishable from the environment by their colour, shape or heat signature.

3. Robots

3.1. Control

1. Robots must be controlled autonomously. The use of a remote control, manual control, or passing information (by external sensors, cables, wirelessly, etc.) to the robot is not allowed.
2. Robots must be started manually by the team captain.
3. Robots may utilize various maze navigation algorithms. Any pre-mapped type of dead reckoning (movements preprogrammed based on known locations or placement of features in the field) is prohibited.
4. A robot must not damage any part of the field in any way.

3.2. Construction

1. The height of a robot must not exceed 30 cm.
2. Robots may not have any sensors or devices that enables it to 'see' over the walls.
3. Any robot kit or building blocks, either available on the market or built from raw hardware, may be used as long as the design and construction are primarily and substantially the original work of the students (see section 3.5. below).
4. Teams are not permitted to use any commercially produced robot kits or sensors components that are specifically designed or marketed to complete any single major task of RoboCupJunior Rescue. Robots that do not comply will face immediate disqualification from the tournament. If there is any doubt, teams should consult the RoboCupJunior Rescue Committee prior to the competition.
5. For the safety of participants and spectators, only lasers of class 1 and 2 are allowed. This will be checked during inspection. Teams using lasers must have the datasheet of the laser, and also must submit them prior to the competition as well as be able to show them during the competition.
6. Wireless communication must be used correctly as described on the [RoboCupJunior General Rules](#). Robots performing other types of wireless communication need to be deleted or disabled. If the robot has other forms of wireless communication equipment, the team needs to prove that they are disabled. Non-conforming robots may be immediately disqualified from the tournament.
7. Robots may incur damage by falling off the field, making contact with another robot, or making contact with field elements. The RoboCupJunior Rescue Committee cannot anticipate all potential situations where damage to the robot may occur. Teams should ensure that all active elements on a

robot are properly protected with resistant materials. For example, electrical circuits must be protected from all human contact and direct contact with other robots and field elements.

8. When batteries are transported, moved, or charged, it is strongly recommended that safety bags be used. Reasonable efforts should be made to ensure that robots avoid short circuits and chemical or air leaks.
9. Robots must be equipped with a handle which is to be used to pick them up during the scoring run.
10. Robots must be equipped with a single binary switch or button, clearly visible to the referee, for restarting the robot when a lack of progress occurs.

3.3. Team

1. Each team must have only one robot in the field.
2. Each team must comply with the [RoboCupJunior General Rules](#) regarding the number of members and each member's age.
3. A student can be registered on only one team across all RoboCupJunior leagues/sub-leagues.
4. A team is only allowed to participate in one league/sub-league in across all RoboCupJunior leagues/sub-leagues.
5. Each team member will need to explain their work and should have a specific technical role.
6. Mentors/parents are not allowed to be with the students during the competition. The students will have to govern themselves (without mentor's supervision or assistance) during the long stretch of hours at the competition.

3.4. Inspection

1. The robots will be scrutinized by a panel of referees before the start of the tournament and at other times during the competition to ensure that they meet the constraints described in these rules.
2. It is illegal to use a robot that is very similar to another team's robot from a previous year or the current year.
3. It is the responsibility of the team to have their robot re-inspected if their robot is modified at any time during the tournament.
4. Students will be asked to explain the operation of their robot in order to verify that construction and programming of the robot is their own work.
5. Students will be asked about their preparation efforts and may be requested to answer surveys and participate in video-taped interviews for research purposes.
6. All teams must complete a web form prior to the competition to allow referees to better prepare for the interviews. Instructions on how to submit the form will be provided to the teams prior to the competition.
7. All teams have to submit their source code prior to the competition. The source code will not be shared with other teams without the team's permission.
8. All teams must submit their engineering journal prior to the competition. The journals will not be

shared with other teams without the team's permission.



However, it is highly recommended that teams publicly share their engineering journal. With the teams that indicate that their engineering journals could be shared publicly during the registration process, the journal alongside their poster presentation will be shared through the RoboCupJunior Forum so that other teams could learn from them.

3.5. Violations

1. Any violations of the inspection rules will prevent the offending robot from competing until modifications are made and the robot passes inspection.
2. Modifications must be made within the time schedule of the tournament and teams cannot delay tournament play while making modifications.
3. If a robot fails to meet all specifications (even with modifications), it will be disqualified from that round (but not from the tournament).
4. No mentor assistance is allowed during the competition. (See [Section 1, "Code of Conduct"](#))
5. Any violations of the rules may be penalized by disqualification from the tournament or the round or may result in a loss of points at the discretion of the referees, officials, RoboCupJunior Rescue Committee or RoboCupJunior General Chairs.

4. Play

4.1. Pre-game Practice

1. When possible, teams will have access to practice fields for calibration and testing throughout the competition.
2. Whenever there are dedicated independent fields for competition and practice, it is at the organizers' discretion if testing is allowed on the competition fields.

4.2. Humans

1. Teams should designate one of their members as "captain" and another one as "co-captain". Only these two team members will be allowed access to the competition fields, unless otherwise directed by a referee. Only the captain will be allowed to interact with the robot during a scoring run.
2. The captain can move the robot only when they are told to do so by a referee.
3. Other team members (and any spectators) within the vicinity of the competition field have to stand at least 150 cm away from the field at all times, unless otherwise directed by a referee.
4. No one is allowed to touch the fields intentionally during a scoring run.
5. Any and all pre-mapping activities will result in immediate disqualification of the robot for the round. Pre-mapping is the act of humans providing the robot with information about the field (e.g.: location of walls, location of silver and black tiles, location and type of victims, etc.) prior to the

game.

4.3. Start of Game

1. Each team has a maximum of 8 minutes for a game. The game includes the time for calibration and the scoring run.
2. Calibration is defined as the taking of sensor readings and modifying a robot's program to accommodate such sensor readings. Calibration does not count as pre-mapping.
3. The scoring run is defined as the time when the robot is moving autonomously to navigate the field, and the referee will record the scores.
4. A game begins at the scheduled starting time whether or not the team is present or ready. Start times will be posted around the venue.
5. Once the game has begun, the robot is not permitted to leave the competition area.
6. Teams may calibrate their robot in as many locations as desired on the field, but the clock will continue to run. Robots are not permitted to move on their own while calibrating.
7. Before a scoring run begins, the referee will roll a standard 6-sided dice or with another method of randomization set by the organizers to determine the location of the black and silver tiles. The position of the black and silver tiles will not be revealed to the team until they are ready to start a scoring run (see [4.3.11](#)). Referees will ensure the combination of black tile placements in a field layout is 'solvable' before a robot begins a scoring run.
8. Before a scoring run begins the referee can change any walls of the field, (see [2.3.6](#)).
9. Once a team is ready to start a scoring run, they must notify the referee. To begin a scoring run, the robot is placed on the start tile of the course as indicated by the referee. Once a scoring run has begun, no more calibration is permitted, including changing of code/code selection.
10. Teams may choose not to calibrate the robot and instead immediately start the scoring run.
11. Once the robot starts moving as the scoring run begins, a referee will place the black and silver tiles.

4.4. Scoring Run

1. Modifying the robot during a scoring run is prohibited, which includes remounting parts that have fallen off.
2. Any parts that the robot loses intentionally or unintentionally will be left in the field until the game is over. Team members and referees are not allowed to move or remove parts from the field during a scoring run.
3. Teams are not allowed to give their robot any advance information about the field. A robot is supposed to recognize the field elements by itself.
4. A "visited tile" means that more than half of the robot is inside the tile when looking from above.

4.5. Lack of Progress

1. A lack of progress occurs when:
 - a. the team captain declares a lack of progress.
 - b. a robot visited the black tile. See definition of visited tile on [4.4.4](#).
 - c. a robot damages the field.
 - d. a team member touches the field or their robot without permission from a referee.
2. In the event of a lack of progress, the robot must return to the last visited checkpoint (or the start tile if never reached a checkpoint). The robot can be installed in any direction. For the definition of the visited tile (see [4.4.4](#)).
3. After a lack of progress, the team must reset the robot by using a switch or button located in a clearly visible location by the referee (see [3.2.10](#)).

4.6. Scoring

1. To successfully identify a victim, the robot must stop within 15 cm a victim and blink an indicator which is visible to the referee for the full 5 seconds while being stationary.
2. Points are rewarded for each Successful Victim Identification in the field.
 - a. For victims located on a tile adjacent to a linear wall (even diagonally), i.e. all victims at the 6 tiles around a linear wall.
 - i. For heated and visual victims: 10 points
 - ii. For coloured victims: 5 points
 - b. On other walls (i.e.: floating walls)
 - i. For heated and visual victims: 30 points
 - ii. For coloured victims: 15 points

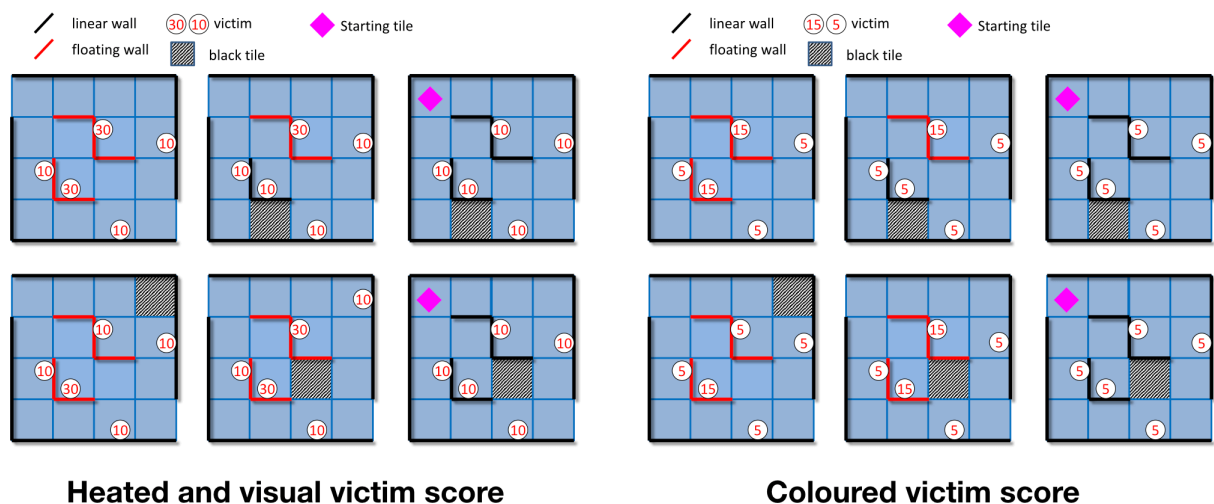



Some of the victims on the floating wall are worth 10 points / 5 points. This is because 10 points / 5 points victims are on a tile near a linear wall. The colour in the figure is for illustration only. The field designer must keep in mind this rule when deciding on the location of the black and silver tiles, which can be changed during the run via a dice roll; in order to keep the maximum score consistent.

3. To successfully deploy a rescue kit, a robot must deploy a rescue kit completely within 15 cm of the victim. The deployment point is determined by the location of the rescue kit when the robot moves completely out of the 15 cm boundary of the victim.
4. 10 points are awarded per successful rescue kit deployment. The following amount of rescue kits points can be scored:
 - a. Heated victims: one rescue kit per victim. (Maximum points for rescue kit deployment per victim: 10 points.)
 - b. Visual victims:
 - i. Harmed (H): three rescue kits per victim. (Maximum points for rescue kit deployment per victim: 30 points.)
 - ii. Stable (S): two rescue kits per victim. (Maximum points for rescue kit deployment per victim: 20 points.)
 - iii. Unharmed (U): zero rescue kit per victim.
 - c. Coloured victims:
 - i. Red: one rescue kit per victim. (Maximum points for rescue kit deployment per victim: 10 points.)
 - ii. Yellow: one rescue kit per victim. (Maximum points for rescue kit deployment per victim: 10 points.)
 - iii. Green: zero rescue kits per victim.
5. Reliability Bonus = the number of 'successful victim identification' \times 10 + the number of 'successful rescue deployment' \times 10, minus the number of 'Lack of Progress' \times 10. However, Reliability Bonus score can only be reduced to the minimum of 0 points.
6. Successful Speed Bump Crossing. For each tile with speed bumps passed, a robot is awarded 5 points.
7. Successful Up or Down Ramp Navigation. A robot is awarded 10 points for a successfully navigating up or down a ramp (i.e.: the robot can score a maximum of 10 points per ramp). The robot has successfully navigated through the ramp when it moves from the bottom to the top tile (or viceversa) and is completely within the horizontal tile without toppling over.
8. Successful Stair Navigation. A robot is awarded 5 points for navigating a set of stairs in either direction (i.e.: the robot can score a maximum of 5 points per a set of stairs). A successful navigation means the robot moves from the bottom tile on one side of the stairs to the top tile and then onto the bottom tile on the other side of the stairs without assistance.
9. Successful Checkpoint Navigation. A robot is awarded 10 points for each visited checkpoint. Refer to [4.4.4](#) for definition of visited tile.

10. **Successful Exit Bonus.** A robot is awarded 10 points for each victim successfully identified (see 4.6.1). The "exit bonus" condition is satisfied when the robot returns to the starting tile, stays there for at least 10 seconds to complete the scoring run.
11. **Ties at the end.** Ties in scoring will be resolved based on the time each robot took to complete the run.
12. **No duplicate rewards.** For example, if a robot successfully crosses a tile with speed bumps multiple times, only one successful speed bump crossing will be rewarded per tile. The same result applies to all other scoring rules.
13. **Misidentification.** If a robot identifies a victim through methods outlined in 4.6.1 but is outside the 15 cm radius of any victim, 5 points will be deducted. This doesn't apply to delivering the incorrect number of rescue kits to victims. The total points will never go below zero points.

4.7. End of Game

1. A team may elect to stop the game early at any time. In this case, the team captain must indicate to the referee the team's desire to terminate the game. The team will be awarded all points earned up to the call for the end of the game. The referee will stop the time at the end of game which will be recorded as the game time.
2. The game ends when:
 - a. the 8 minutes of allowed game time expires
 - b. the team captain calls end of game
 - c. the robot returns to the start tile and is awarded the exit bonus

5. Open Technical Evaluation

5.1. Description

1. Your technical innovation will be evaluated during a dedicated time frame. All teams need to prepare for an open display during this time frame.
2. Judges will circulate and interact with the teams. The Open Technical Evaluation is intended to be a casual conversation with a "question and answer" atmosphere.
3. The main objective of the Open Technical Evaluation is to emphasize the ingenuity of innovation. Being innovative may mean technical advances as compared to the existing knowledge, or an out-of-the-ordinary, simple but clever, solution to existing tasks.

5.2. Evaluation Aspects

1. A standardized rubric system will be used focusing on:
 - creativity
 - cleverness

- simplicity
 - functionality
2. Your "work" can include (but is not limited to) one of the following aspects:
 - creation of your own sensor instead of a pre-built sensor
 - creation of a "sensor module" which is comprised of various electronics resulting in a self-contained module to provide a certain functionality
 - creation of a mechanical invention which is functional, but out of the ordinary
 - creation of a new software algorithm to a solution
 3. Teams must provide documents that explain their work. Each invention must be supported by concise but clear documentation. The documents must show precise steps towards the creation of the invention.
 4. Documents must include one poster and one engineering journal. Teams should be prepared to explain their work.
 5. Engineering Journals should demonstrate your best practices in the development process.
 6. The poster should include name of team, country, league, robot description, robot capabilities, controller and programming language used, sensors included, method of construction, time used for development, cost of materials and awards won by the team in its country, etc.

5.3. Sharing

1. Teams are encouraged to review other's posters and presentations.
2. Teams awarded with certificates are required to post their documents and presentation online when asked by the RoboCupJunior Rescue Committee.

6. Conflict Resolution

6.1. Referee and Referee Assistant

1. All decisions during game play are made by the referee or the referee assistant, who are in charge of the field, persons and objects surrounding them.
2. During game play, the decisions made by the referee and/or the referee assistant are final.
3. At conclusion of game play, the referee will ask the captain to sign the score sheet. Captains will be given a maximum of 1 minute to review the score sheet and sign it. By signing the score sheet, the captain accepts the final score on behalf of the entire team. In case of further clarification, the team captain should write their comments on the score sheet and sign it.

6.2. Rule Clarification

1. If any rule clarification is needed, please contact the [International RoboCupJunior Rescue Committee](#)



through the [RoboCupJunior Forum](#).

2. If necessary even during a tournament, a rule clarification may be made by members of the [International RoboCupJunior Rescue Committee](#).

6.3. Special Circumstances

1. If special circumstances, such as unforeseen problems or capabilities of a robot occur, rules may be modified by the RoboCupJunior Rescue Committee Chair in conjunction with available committee members, even during a tournament.
2. If any of the team captains/mentors do not show up to the team meetings to discuss problems and the resulting rule modifications described at [6.3.1](#), it will be understood that they agreed and were aware of the changes.